

# 2019 LED LIGHT

Simple • Classic • Smart



LUMITEK INTERNATIONAL CO.,LTD  
Add : No.18, Lane239, Beihai Road, Jiangbei, Ningbo, China  
Tel : +86-574-88165605 Fax : +86-574-88165666  
E-mail : jacky@lumitek.cn www.lumitek-lighting.com

# ABOUT LUMITEK

Lumitek Group is a company focusing on making people live better and easier through technology and innovation in the field of Electrical, LED Lighting and Dometique. This has been Lumitek's mission since our inception in 1998.



## ● Research

With a focus on promoting future development, Lumitek has been involved in innovative LED technology, collaborating closely with partners from the commercial teams as well as with universities and colleagues. Additionally, the high priority attached to ongoing marketing investigation has spawned many innovations and optimized the product portfolio.



## ● Design

Lumitek aims to strengthen our characteristic feature in LED lighting products through added investment on design. We cooperate with French, Italian designer team for industry design, while at the same time with professional graphic designs team for package, brochure and posters, etc. The designs meet different requirement of lighting not only for easy installation, energy saving, long life but also meet the tastes of different market.



## ● Production

At Lumitek, to produce qualified products is our responsibility. Integrated Management System - ISO9001:2008, ISO14001:2000, OHSAS18001:2007 - makes Lumitek to be one of the reliable cooperators in the area of LED lighting.

## ● Quality

We have established high-level testing laboratory, with testing facilities for LVD, EMC and optical parameters. It grants us great advantages for R&D and quality control for mass production.



Integrating Sphere



EMC (EMI/EMS) Testing



Safety Testing



Dark Room



IPXX Testing



# Index

## LED Flood Light



Tynee **7-10**



Tynee **11-16**



Crystal **17-20**



Plus-R **21-22**



Plus-S **23-24**



Doublux **25-26**



Terminus **27-28**



Plus-R Z  
Crystal-Z **31-32**



Tripod **33**



Spike **34**

## LED Bulkhead Light



Moon X **37-38**



Stone **39-40**



Gaudi **41-42**



Moon **43-44**



Moon Classical **45-46**



Lynx Pro **47-48**



Lynx **49-50**

## LED Tri-proof Light



Cosmos **53-54**



Cosmos Plus **55-56**



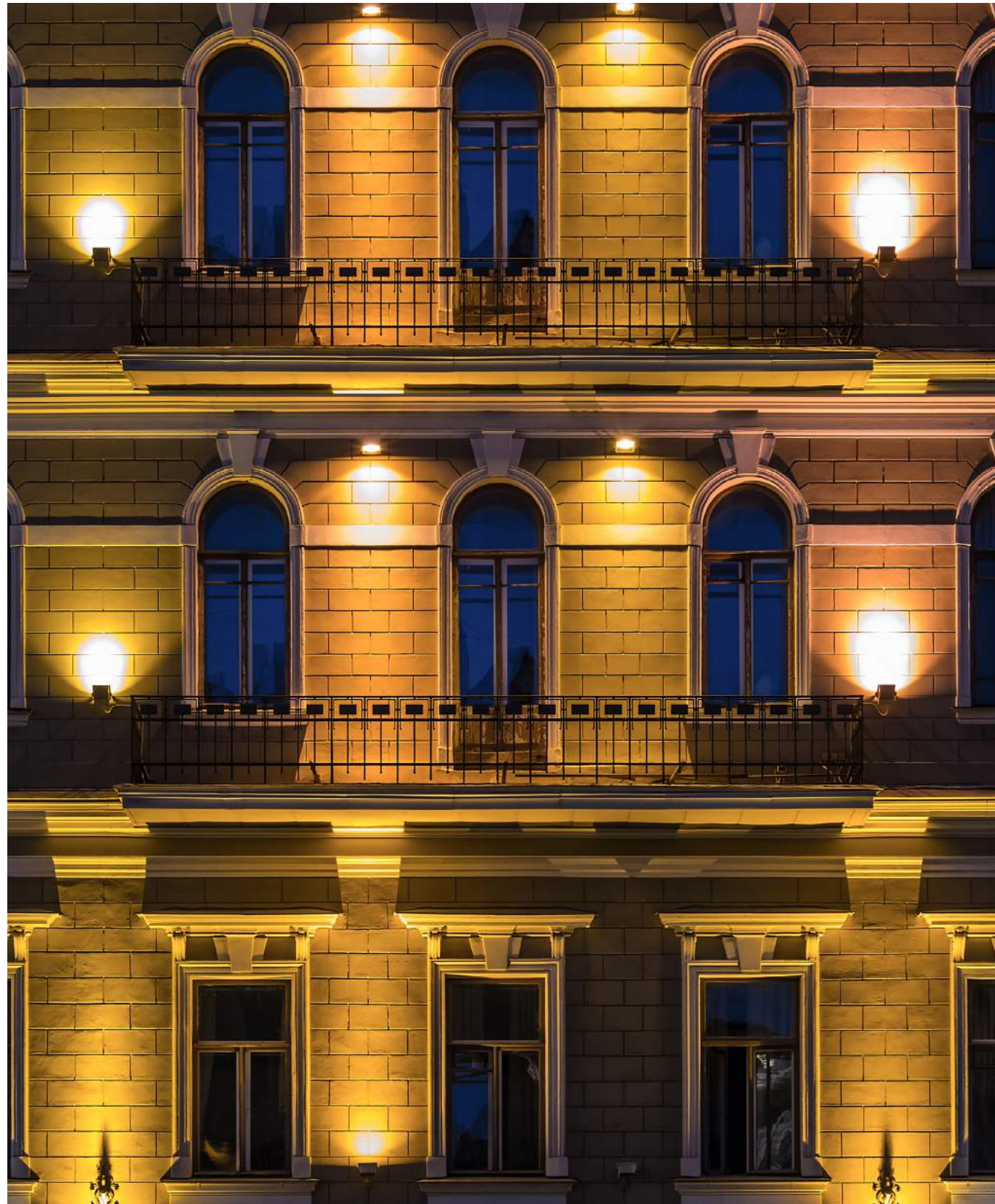







## LED Flood Light

Light has a great effect on us humans, not only does it allow us to see. Light stimulates us, and influences our moods and activity levels.

The flood light is mostly used outdoor. With years of expertise and experience in flood light, we devote ourselves to building better light effect, and most elegant and ultra-slim designs - for well human-being with light.

## LED Flood Light

Series Name	Tynee	Crystal	Plus-R	Plus-S	Doublux	Terminus	Plus-R Z Crystal-Z Work light
Photo							
Page	7-16	17-20	21-22	23-24	25-26	27-28	31-32
Diffuser	PC/Glass	PC	PC	PC	PC(Front) Glass(Back)	Glass	PC
Wattage	10-70W	10-50W	10-50W	10-50W	24-80W	10-100W	10-50W
Lifetime	30000H	30000H	30000H	30000H	30000H	20000H	30000H
SAA	X	X	X	√	X	X	X
IP	65	65	65	65	65	65	44
IK	Glass: 8 PC: 10	10	10	10	10	8	10
Lm/W	Glass: > 80 PC: > 70	> 70	> 70	> 80	> 70	> 80	> 70
Spike	X	√	√	√	X	X	X
PIR	√	√	√	√	X	√	X
Beam angle	120°	120°	120°	120°	120°	120°	120°
Exposed cable	Optional	Optional	Optional	Optional	√	√	√
IP68 Fast install connector	√	√	√	√	X	X	X
New bracket	Optional	X	X	X	X	X	X
Solar powered	√ (10W/20W)	X	X	X	X	X	X
Driver solution	Linear IC						
CE/Rohs	√						
Fixture color	White/Black/Grey						
Available CCT	3000/4000/6000K						
Warranty	2years						

# Advanced Waterproof Fast Connection

Material  
PA66 Nylon



# NEW



available wiring cable spec:  $\phi$  5-10mm  
available for 3 core cable



# Flexible Floodlight New Bracket

Material  
PA66 Nylon

# NEW

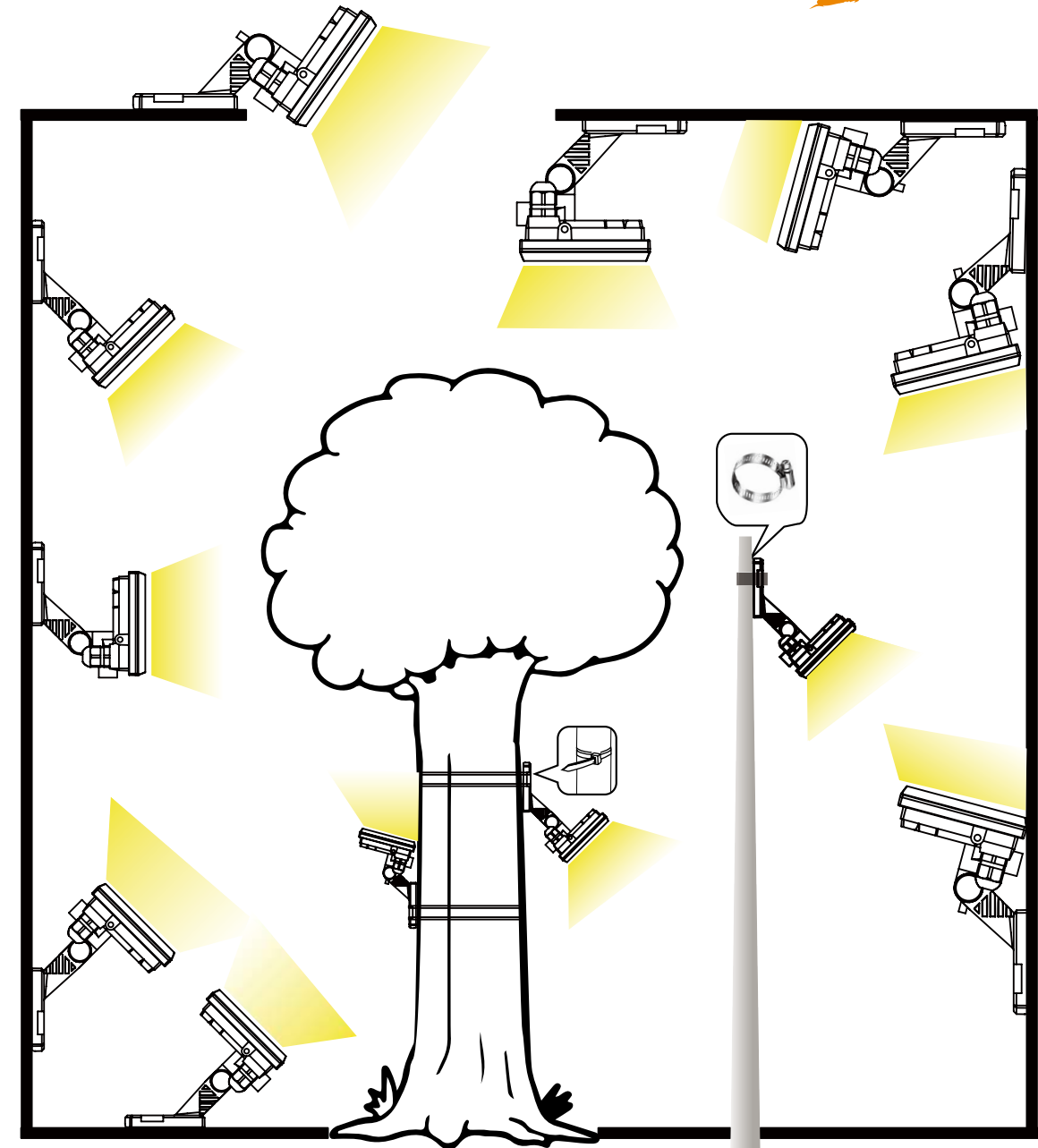

Flood Light installation instruction diagram with new bracket



# Tynee

Curved PC diffuser  
Material  
Die-Casting Alu+PC  
Quality Guarantee  
**2 YEARS**



Anti-UV

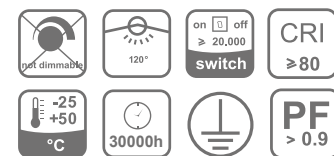
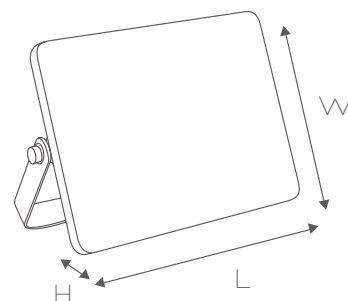

## Tynee Series



with 20cm(H05RN-F 3G 10mm<sup>2</sup>) exposed cable

- LFP0F010
- LFP0F020
- LFP0F030
- LFP0F050
- LFP0F070



with IP68 fast connector

- LFP0F010-T
- LFP0F020-T
- LFP0F030-T
- LFP0F050-T
- LFP0F070-T



with 20cm(H05RN-F 3G 10mm<sup>2</sup>) exposed cable and new bracket

- LFP1F010
- LFP1F020
- LFP1F030
- LFP1F050
- LFP1F070



with IP68 fast connector and new bracket

- LFP1F010-T
- LFP1F020-T
- LFP1F030-T
- LFP1F050-T
- LFP1F070-T

## Chart Test Data

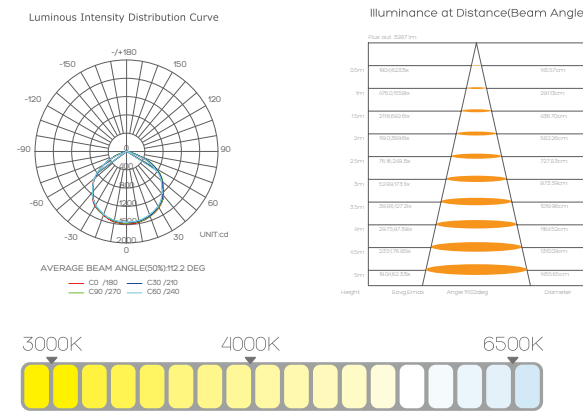

## Details



Waterproof Plug



IP68 Fast Connection



New Bracket

## Table Data

Part No.	Voltage(V)	Power (W) Consumption	Lumen(lm)	Dimension(mm) (L*W*H)	pcs/CTN (pcs)	Q'ty for 20GP	Q'ty for 40HQ
LFP0F010	AC220~240V	10	700	105*102*70	20	21700	47300
LFP0F020	AC220~240V	20	1400	135*102*70	20	17500	42500
LFP0F030	AC220~240V	30	2100	165*114*70	20	13020	31640
LFP0F050	AC220~240V	50	3500	210*142*70	10	8650	21020
LFP0F070	AC220~240V	70	4900	270*184*70	10	5380	13070
LFP0F010-T	AC220~240V	10	700	105*102*70	20	17500	42500
LFP0F020-T	AC220~240V	20	1400	135*102*70	20	13020	31640
LFP0F030-T	AC220~240V	30	2100	165*114*70	20	17300	42040
LFP0F050-T	AC220~240V	50	3500	210*142*70	10	8650	21020
LFP0F070-T	AC220~240V	70	4900	270*184*70	10	5380	13070
LFP1F010	AC220~240V	10	700	105*133*100	20	12440	30240
LFP1F020	AC220~240V	20	1400	135*153*100	20	8880	21600
LFP1F030	AC220~240V	30	2100	165*173*100	20	6680	16240
LFP1F050	AC220~240V	50	3500	210*203*100	10	4560	11080
LFP1F070	AC220~240V	70	4900	270*243*100	10	3080	7490
LFP1F010-T	AC220~240V	10	700	105*133*100	20	12440	30240
LFP1F020-T	AC220~240V	20	1400	135*153*100	20	8880	21600
LFP1F030-T	AC220~240V	30	2100	165*173*100	20	6680	16240
LFP1F050-T	AC220~240V	50	3500	210*203*100	10	4560	11080
LFP1F070-T	AC220~240V	70	4900	270*243*100	10	3080	7490

# Tynee

Curved PC diffuser  
Material  
Die-Casting Alu+ PC  
Quality Guarantee  
**2 YEARS**



Anti-UV



Available for PIR

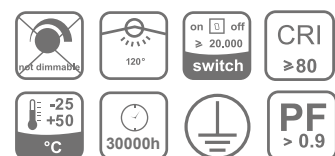
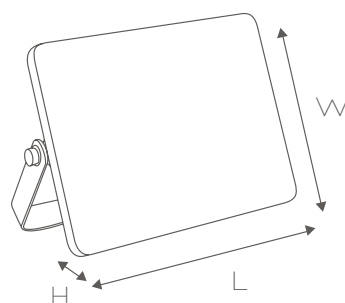

## Tynee Series



with 20cm(H05RN-F 3G 10mm<sup>2</sup>)exposed cable

LFP0F010S  
LFP0F020S  
LFP0F030S  
LFP0F050S  
LFP0F070S



with IP68 fast connector

LFP0F010S-T  
LFP0F020S-T  
LFP0F030S-T  
LFP0F050S-T  
LFP0F070S-T



with 20cm(H05RN-F 3G 10mm<sup>2</sup>) exposed cable and new bracket

LFP1F010S  
LFP1F020S  
LFP1F030S  
LFP1F050S  
LFP1F070S



with IP68 fast connector and new bracket

LFP1F010S-T  
LFP1F020S-T  
LFP1F030S-T  
LFP1F050S-T  
LFP1F070S-T

## Chart Test Data

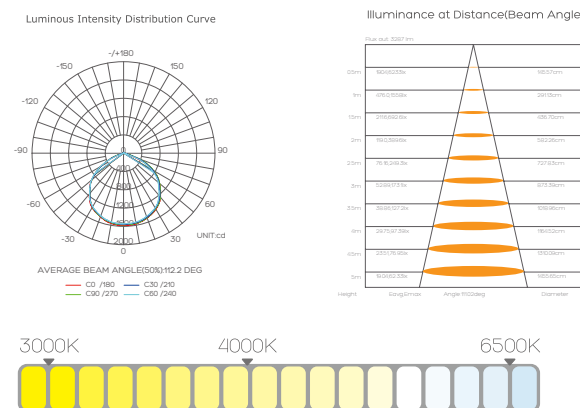

## Details

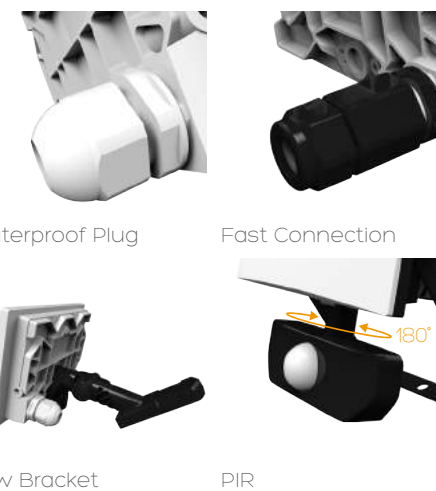

## Table Data

Part No.	Voltage(V)	Power (W) Consumption	Lumen(lm)	Dimension(mm) (L*W*H)	pcs/CTN (pcs)	Q'ty for 20GP	Q'ty for 40HQ
LFP0F010S	AC220~240V	10	700	105*143*70	20	15780	38320
LFP0F020S	AC220~240V	20	1400	135*165*70	20	11340	27560
LFP0F030S	AC220~240V	30	2100	165*185*70	20	8580	20840
LFP0F050S	AC220~240V	50	3500	210*217*70	10	5890	14320
LFP0F070S	AC220~240V	70	4900	270*254*70	10	4160	10110
LFP0F010S-T	AC220~240V	10	700	105*143*70	20	15780	38320
LFP0F020S-T	AC220~240V	20	1400	135*165*70	20	11340	27560
LFP0F030S-T	AC220~240V	30	2100	165*185*70	20	8580	20840
LFP0F050S-T	AC220~240V	50	3500	210*217*70	10	5890	14320
LFP0F070S-T	AC220~240V	70	4900	270*254*70	10	4010	9740
LFP1F010S	AC220~240V	10	700	105*133*100	20	12440	30240
LFP1F020S	AC220~240V	20	1400	135*153*100	20	8880	21600
LFP1F030S	AC220~240V	30	2100	165*173*100	20	6680	16240
LFP1F050S	AC220~240V	50	3500	210*203*100	10	4560	11080
LFP1F070S	AC220~240V	70	4900	270*243*100	10	3080	7490
LFP1F010S-T	AC220~240V	10	700	105*133*100	20	12440	30240
LFP1F020S-T	AC220~240V	20	1400	135*153*100	20	8880	21600
LFP1F030S-T	AC220~240V	30	2100	165*173*100	20	6680	16240
LFP1F050S-T	AC220~240V	50	3500	210*203*100	10	4560	11080
LFP1F070S-T	AC220~240V	70	4900	270*243*100	10	3080	7490

# Tynee

Material  
Die-Casting Alu+ Glass  
Quality Guarantee  
**2 YEARS**

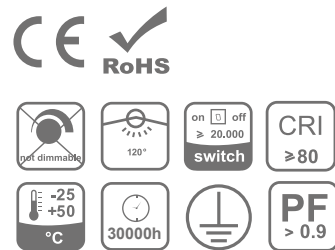
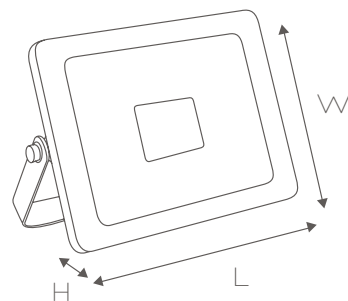

## Tynee Series



with 20cm(H05RN-F 3G 10mm<sup>2</sup>) exposed cable

- LFG0F010
- LFG0F020
- LFG0F030
- LFG0F050
- LFG0F070



with IP68 fast connector

- LFG0F010-T
- LFG0F020-T
- LFG0F030-T
- LFG0F050-T
- LFG0F070-T



with 20cm(H05RN-F 3G 10mm<sup>2</sup>) exposed cable and new bracket

- LFG1F010
- LFG1F020
- LFG1F030
- LFG1F050
- LFG1F070



with IP68 fast connector and new bracket

- LFG1F010-T
- LFG1F020-T
- LFG1F030-T
- LFG1F050-T
- LFG1F070-T

## Chart Test Data

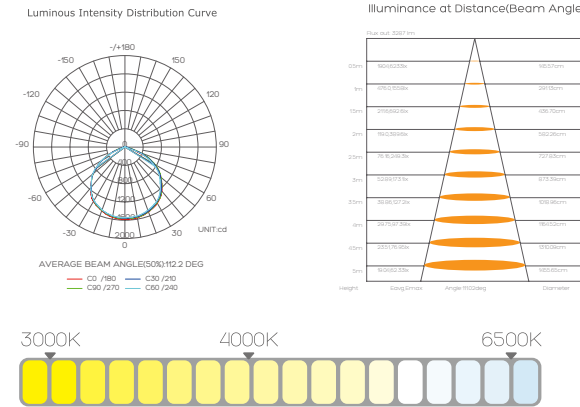

## Details

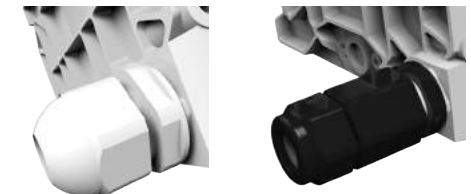

Waterproof Plug

Fast Connection



New Bracket

## Table Data

Part No.	Voltage(V)	Power (W) Consumption	Lumen(lm)	Dimension(mm) (L*W*H)	pcs/CTN (pcs)	Q'ty for 20GP	Q'ty for 40HQ
LFG0F010	AC220~240V	10	800	105*102*70	20	24560	59640
LFG0F020	AC220~240V	20	1600	135*102*70	20	19800	48100
LFG0F030	AC220~240V	30	2400	165*114*70	20	14740	35820
LFG0F050	AC220~240V	50	4000	210*142*70	10	9790	23790
LFG0F070	AC220~240V	70	5600	270*184*70	10	6090	14790
LFG0F010-T	AC220~240V	10	800	105*102*61	20	24560	59640
LFG0F020-T	AC220~240V	20	1600	135*102*61	20	19800	48100
LFG0F030-T	AC220~240V	30	2400	165*114*61	20	14740	35820
LFG0F050-T	AC220~240V	50	4000	210*142*61	10	9790	23790
LFG0F070-T	AC220~240V	70	5600	270*184*61	10	6090	14790
LFG1F010	AC220~240V	10	800	105*133*91	20	13620	33100
LFG1F020	AC220~240V	20	1600	135*153*91	20	9720	23640
LFG1F030	AC220~240V	30	2400	165*173*91	20	7320	17780
LFG1F050	AC220~240V	50	4000	210*203*91	10	4990	12130
LFG1F070	AC220~240V	70	5600	270*243*91	10	3370	8200
LFG1F010-T	AC220~240V	10	800	105*133*91	20	14200	34480
LFG1F020-T	AC220~240V	20	1600	135*153*91	20	9720	23640
LFG1F030-T	AC220~240V	30	2400	165*173*91	20	7320	17780
LFG1F050-T	AC220~240V	50	4000	210*203*91	10	4990	12130
LFG1F070-T	AC220~240V	70	5600	270*243*91	10	3370	8200

# Tynee

Material  
Die-Casting Alu+ Glass  
Quality Guarantee  
2 YEARS



Available for PIR

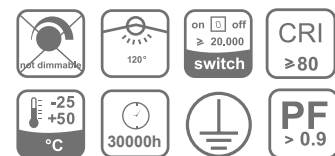
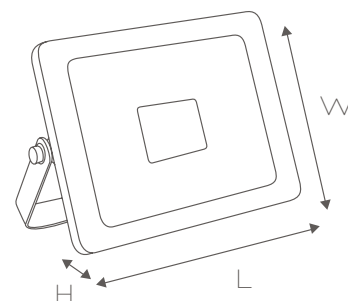

## Tynee Series



with 20cm(H05RN-F 3G 10mm<sup>2</sup>) exposed cable

LFG0F010S  
LFG0F020S  
LFG0F030S  
LFG0F050S  
LFG0F070S



with IP68 fast connector

LFG0F010S-T  
LFG0F020S-T  
LFG0F030S-T  
LFG0F050S-T  
LFG0F070S-T



with 20cm(H05RN-F 3G 10mm<sup>2</sup>) exposed cable and new bracket

LFG1F010S  
LFG1F020S  
LFG1F030S  
LFG1F050S  
LFG1F070S



with IP68 fast connector and new bracket

LFG1F010S-T  
LFG1F020S-T  
LFG1F030S-T  
LFG1F050S-T  
LFG1F070S-T

## Chart Test Data

Luminous Intensity Distribution Curve

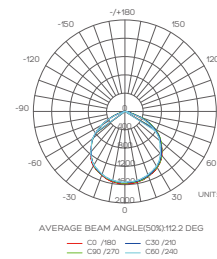

Illuminance at Distance(Beam Angle)

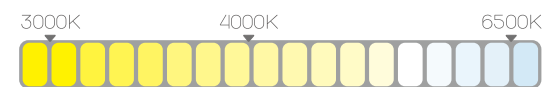
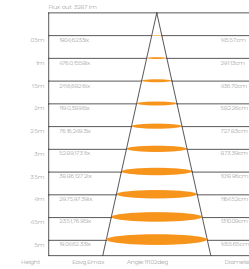

## Details



Waterproof Plug



Fast Connection

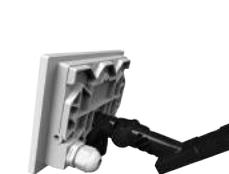

New Bracket

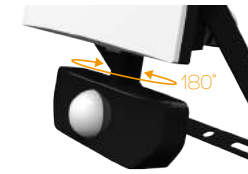

PIR

## Table Data

Part No.	Voltage(V)	Power (W) Consumption	Lumen(lm)	Dimension(mm) (L*W*H)	pcs/CTN (pcs)	Q'ty for 20GP	Q'ty for 40HQ
LFG0F010S	AC220~240V	10	800	105*143*61	20	17860	43380
LFG0F020S	AC220~240V	20	1600	135*165*61	20	12840	31200
LFG0F030S	AC220~240V	30	2400	165*185*61	20	9700	23580
LFG0F050S	AC220~240V	50	4000	210*217*61	10	6670	16200
LFG0F070S	AC220~240V	70	5600	270*254*61	10	4540	11020
LFG1F010S	AC220~240V	10	800	105*143*61	20	17860	43380
LFG1F020S	AC220~240V	20	1600	135*165*61	20	12840	31200
LFG1F030S	AC220~240V	30	2400	165*185*61	20	9700	23580
LFG1F050S	AC220~240V	50	4000	210*217*61	10	6670	16200
LFG1F070S	AC220~240V	70	5600	270*254*61	10	4540	11020
LFG1F010S-T	AC220~240V	10	800	105*133*91	20	13620	33100
LFG1F020S-T	AC220~240V	20	1600	135*153*91	20	9720	23640
LFG1F030S-T	AC220~240V	30	2400	165*173*91	20	7320	17780
LFG1F050S-T	AC220~240V	50	4000	210*203*91	10	4990	12130
LFG1F070S-T	AC220~240V	70	5600	270*243*91	10	3370	8200
LFG1F010S-T	AC220~240V	10	800	105*133*91	20	13620	33100
LFG1F020S-T	AC220~240V	20	1600	135*153*91	20	9720	23640
LFG1F030S-T	AC220~240V	30	2400	165*173*91	20	7320	17780
LFG1F050S-T	AC220~240V	50	4000	210*203*91	10	4990	12130
LFG1F070S-T	AC220~240V	70	5600	270*243*91	10	3370	8200



# Tyneee Solar

Material

Die-Casting Alu+ PC

Die-Casting Alu+ Glass

Quality Guarantee

1 YEARS



Anti-UV



## Tyneee Solar Series



SLFP0F010  
SLFP0F020



SLFP0F010S  
SLFP0F020S



SLFG0F010  
SLFG0F020



SLFG0F010S  
SLFG0F020S

## Chart Test Data

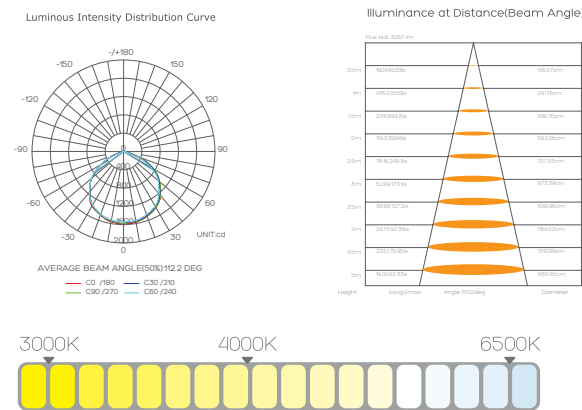

## Details

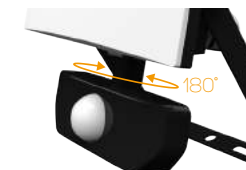

PIR



Replaceable Battery Pack

## Table Data

Part No.	Voltage(V)	Power (W)	Solar panel	Battery capacity	Battery full charged time	full charged working time	Lumen(lm)	Dimension(mm) (L*W*H)	pcs/CTN (pcs)	Q'ty for 20GP
SLFP0F010	DC12V	10	12V/5W	2X2200mah	6h	8h	700	105*102*70	10	3400
SLFP0F020	DC12V	20	12V/10W	3X2200mah	6h	10h	1400	135*102*70	5	1770
SLFG0F010	DC12V	10	12V/5W	2X2200mah	6h	8h	800	105*102*61	10	3670
SLFG0F020	DC12V	20	12V/10W	3X2200mah	6h	10h	1600	135*102*61	5	1770
SLFP0F010S	DC12V	10	12V/5W	1X2200mah	3h	4h	700	105*143*70	10	3400
SLFP0F020S	DC12V	20	12V/5W	2X2200mah	6h	7h	1400	135*165*70	10	3400
SLFG0F010S	DC12V	10	12V/5W	1X2200mah	3h	4h	800	105*143*61	10	3670
SLFG0F020S	DC12V	20	12V/5W	2X2200mah	6h	7h	1600	135*165*61	10	3670

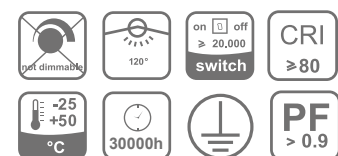

# Crystal

Material  
**Die-Casting Alu+ PC**  
 Quality Guarantee  
**2 YEARS**



Anti-UV

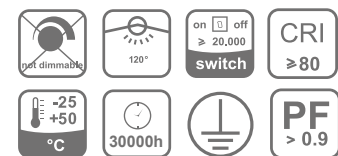
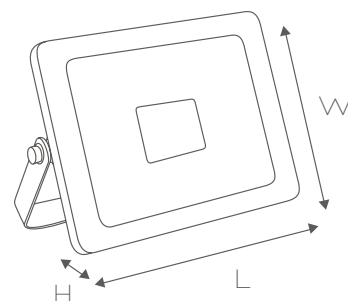

## Crystal Series

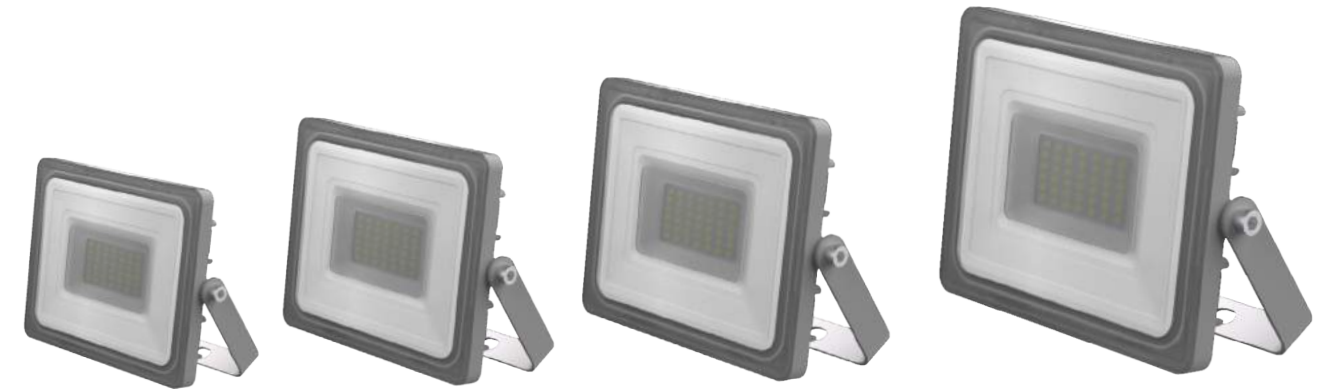

## Chart Test Data

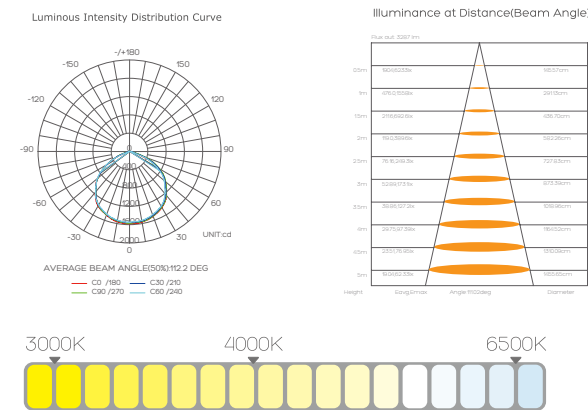

## Details



Terminal box



IP68 fast connector

## Table Data









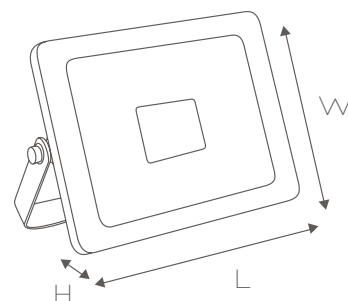

Part No.	Voltage(V)	Power (W) Consumption	IP68 fast connector	Lumen(lm)	Dimension(mm) (L*W*H)	pcs/CTN (pcs)	Q'ty for 20GP	Q'ty for 40HQ
LF00E010	AC220-240V	10	X	700	117*92*55	20	26540	64480
LF00E020	AC220-240V	20	X	1400	150*108*55	20	18540	45060
LF00E030	AC220-240V	30	X	2100	185*135*55	20	12400	30140
LF00E050	AC220-240V	50	X	3500	215*155*55	10	9380	22800
LF00E010-T	AC220-240V	10	√	700	117*92*62	20	24800	60240
LF00E020-T	AC220-240V	20	√	1400	150*108*65	20	15640	37980
LF00E030-T	AC220-240V	30	√	2100	185*135*65	20	10860	26420
LF00E050-T	AC220-240V	50	√	3500	215*155*65	10	8230	19980

# Crystal with PIR

Material  
Die-Casting Alu+ PC  
Quality Guarantee  
**2 YEARS**

 Anti-UV  
 IK 10  
 IP54  
 180°  
 Softlux  
 Available for  PIR



  RoHS  
 dimmable  
 120°  
 on/off switch  
 CRI ≥ 80  
 -25/+50 °C  
 30000h  
  
 PF > 0.9

## Crystal with PIR Series



## Chart Test Data

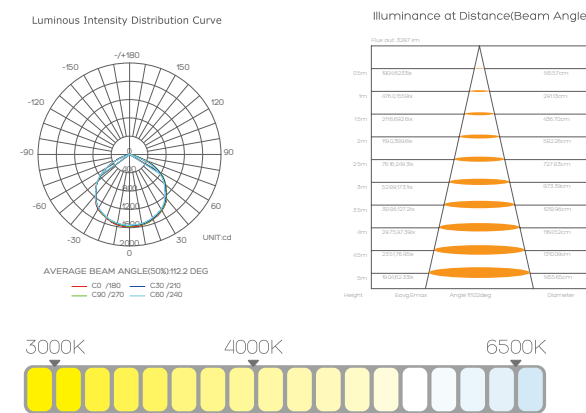

## Details



Terminal box

IP68 fast connector

## Table Data

Part No.	Voltage(V)	Power (W) Consumption	IP68 fast connector	Lumen(lm)	Dimension(mm) (L*W*H)	pcs/CTN (pcs)	Q'ty for 20GP	Q'ty for 40HQ
LF00E010S	AC220-240V	10	X	700	117*150*57	20	17180	41720
LF00E020S	AC220-240V	20	X	1400	150*166*57	20	12520	30440
LF00E030S	AC220-240V	30	X	2100	185*193*57	20	8940	21720
LF00E050S	AC220-240V	50	X	3500	215*213*57	10	6990	16980
LF00E010S-T	AC220-240V	10	√	700	117*150*64	20	15060	36580
LF00E020S-T	AC220-240V	20	√	1400	150*166*67	20	10980	26680
LF00E030S-T	AC220-240V	30	√	2100	185*193*67	20	7840	19040
LF00E050S-T	AC220-240V	50	√	3500	215*213*67	10	6120	14880



# Plus-R

Material  
**Die-Casting Alu+ PC**  
 Quality Guarantee  
**2 YEARS**



Anti-UV

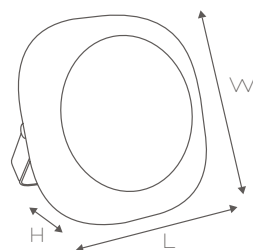
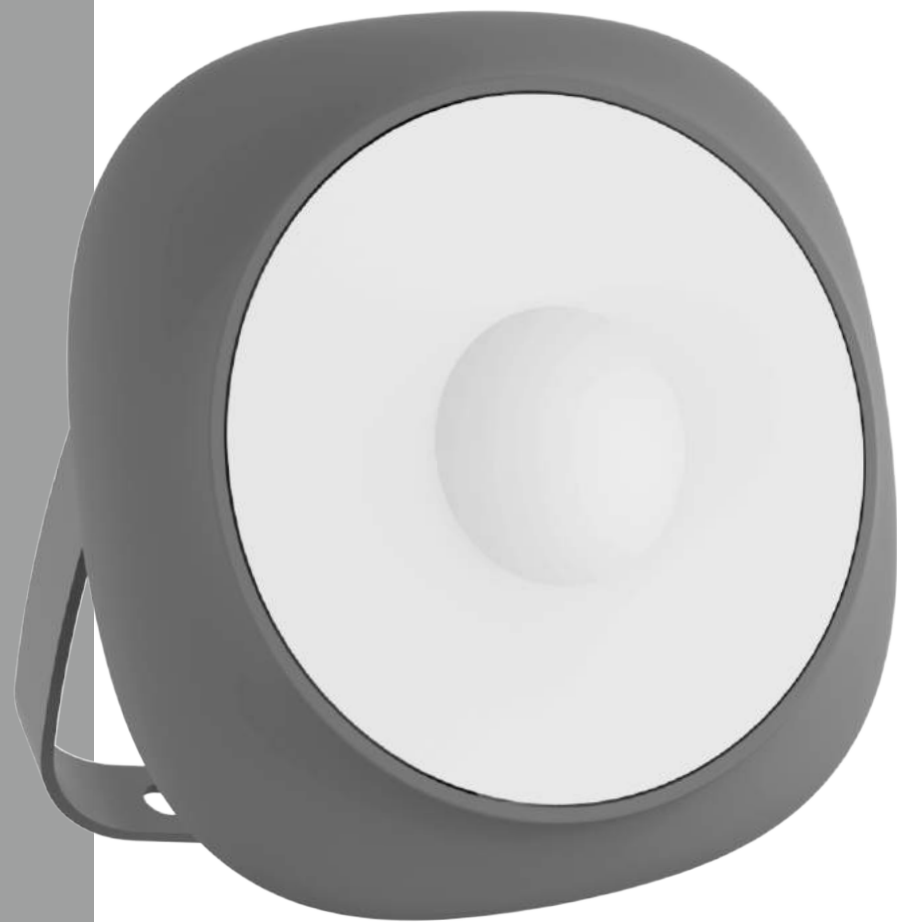

## Plus-R Series

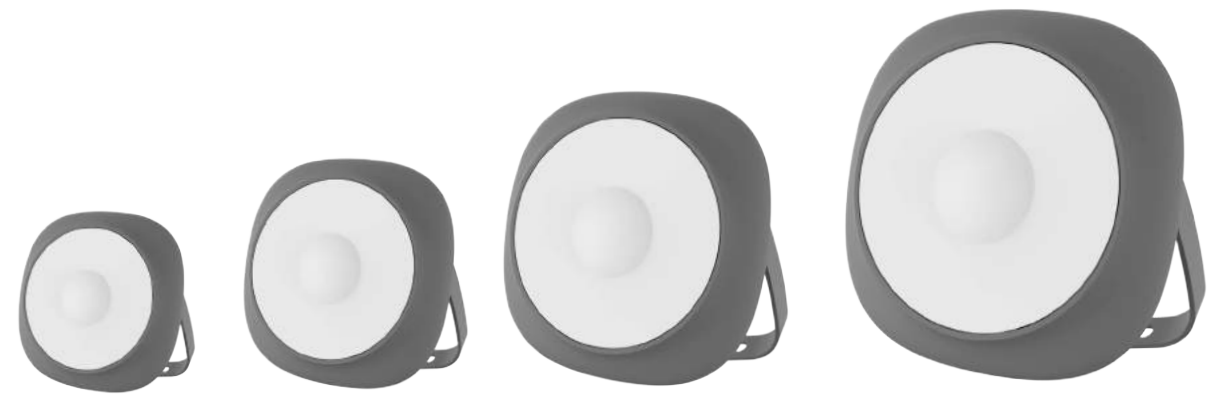

## Chart Test Data

Luminous Intensity Distribution Curve

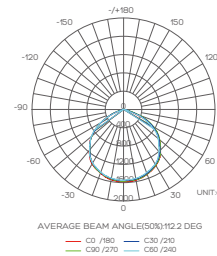

Illuminance at Distance(Beam Angle)

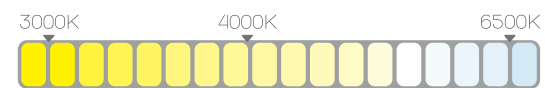
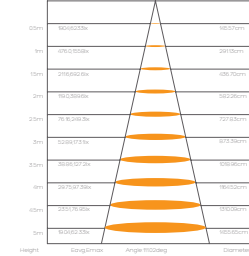

## Details



Exposed cable



IP68 fast connector

## Table Data

Part No.	Voltage(V)	Power (W) Consumption	IP68 fast connector	Lumen(lm)	Dimension(mm) (L*W*H)	pcs/CTN (pcs)	Q'ty for 20GP	Q'ty for 40HQ
LF00D010	AC220-240V	10	X	700	104*100*46	20	25100	60960
LF00D020	AC220-240V	20	X	1400	137*130*46	20	14380	34940
LF00D030	AC220-240V	30	X	2100	174*165*46	20	9080	22060
LF00D050	AC220-240V	50	X	3500	209*200*45	10	5890	14320
LF00D010-T	AC220-240V	10	√	700	104*100*55	20	26280	63840
LF00D020-T	AC220-240V	20	√	1400	137*130*59	20	15840	38480
LF00D030-T	AC220-240V	30	√	2100	174*165*63	20	10200	24800
LF00D050-T	AC220-240V	50	√	3500	209*200*64	10	6680	16230

# Plus-S

Material  
Die-Casting Alu+ PC  
Quality Guarantee  
**2 YEARS**



Anti-UV



Available for PIR

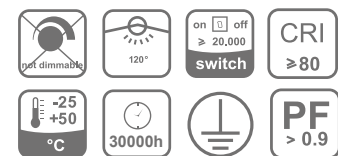
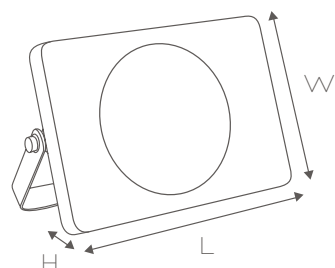

## Plus-S Series



## Chart Test Data

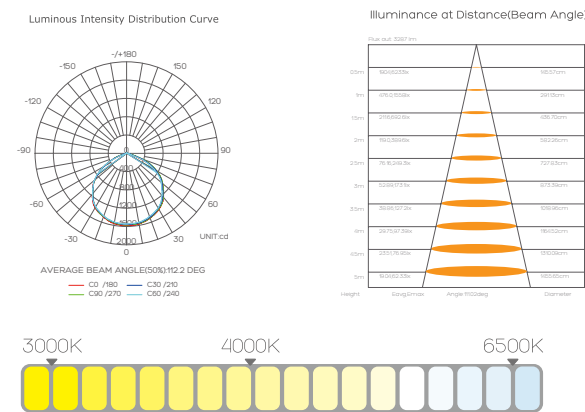

## Details



Exposed cable

IP68 fast connector

## Table Data

Part No.	Voltage(V)	Power (W)	Lumen(lm)	Sensor	IP68 fast connector	Dimension(mm) (L*W*H)	pcs/CTN (pcs)	Q'ty for 20GP	Q'ty for 40HQ
LF00B010	AC220-240V	10	800	X	X	130*101*37	20	18420	44720
LF00B020	AC220-240V	20	1600	X	X	153*121*48	20	10320	25080
LF00B030	AC220-240V	30	2400	X	X	190*147*52	20	9140	22180
LF00B050	AC220-240V	50	4000	X	X	230*177*58	10	4670	11340
LF00B010S	AC220-240V	10	800	√	X	130*141*37	20	22860	55540
LF00B020S	AC220-240V	20	1600	√	X	153*161*48	20	14560	35380
LF00B030S	AC220-240V	30	2400	√	X	190*187*52	20	9840	23920
LF00B050S	AC220-240V	50	4000	√	X	230*217*58	10	6580	15980
LF00B010-T	AC220-240V	10	800	X	√	130*101*60	20	20460	49700
LF00B020-T	AC220-240V	20	1600	X	√	153*121*63	20	15460	37580
LF00B030-T	AC220-240V	30	2400	X	√	190*147*71	20	9380	22800
LF00B050-T	AC220-240V	50	4000	X	√	230*177*72	10	6660	16200
LF00B010S-T	AC220-240V	10	800	√	√	130*141*60	20	15340	37280
LF00B020S-T	AC220-240V	20	1600	√	√	153*161*63	20	11680	28400
LF00B030S-T	AC220-240V	30	2400	√	√	190*187*71	20	7560	18360
LF00B050S-T	AC220-240V	50	4000	√	√	230*217*72	10	5430	13190

# Doublux

Material  
**Die-Casting Alu+ PC**  
 Quality Guarantee  
**2 YEARS**



Anti-UV

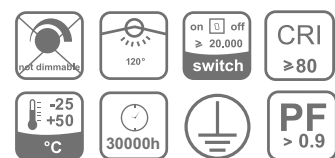
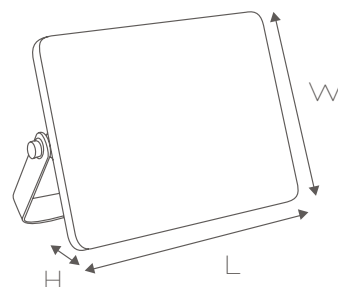

## Doublux Series



## Chart Test Data

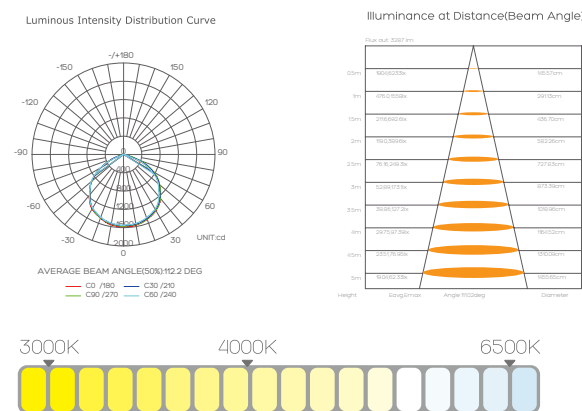

## Details



## Table Data

Part No.	Voltage(V)	Power (W) Consumption	Lumen(lm)	Dimension(mm) (L*W*H)	pcs/CTN (pcs)	Qty for 20GP	Qty for 40HQ
LF0SC010	AC220-240V	20+4	1400+280	150*110*53	20	17000	41600
LF0SC020	AC220-240V	30+4	2100+280	183*140*53	20	11600	28200
LF0SC030	AC220-240V	50+10	3500+700	215*160*53	20	9000	22000
LF0SC050	AC220-240V	70+10	4900+700	260*200*53	10	3100	7600



# Terminus

Material  
**Die-Casting Alu+ PC**  
 Quality Guarantee  
**2 YEARS**



Available for **PIR**

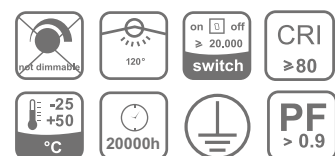
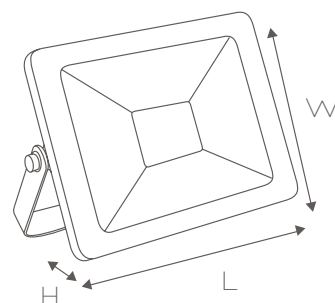

## Terminus Series



LFF010  
 LFF020  
 LFF030  
 LFF050  
 LFF0100



LFF010S  
 LFF020S  
 LFF030S  
 LFF050S

## Chart Test Data

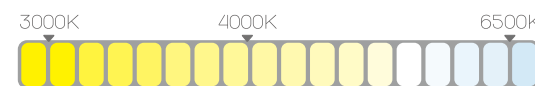
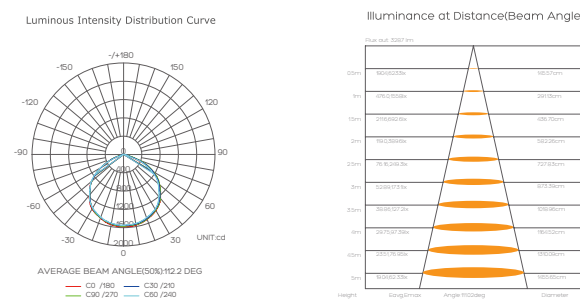

## Details



With 15CM (H05RN-F 3G 1.0mm<sup>2</sup>)  
 exposed cable

## Table Data

Part No.	Voltage(V)	Power (W) Consumption	Lumen(lm)	Dimension(mm) (L*W*H)	pcs/CTN (pcs)	Q'ty for 20GP	Q'ty for 40HQ
LFF010	AC220-240V	10	800	90*70*20	20	78560	190780
LFF020	AC220-240V	20	1600	120*90*20	20	50500	122640
LFF030	AC220-240V	30	2400	150*130*21.9	20	30500	74060
LFF050	AC220-240V	50	4000	190*170*21.3	10	18600	45180
LFF100	AC220-240V	100	8000	260*240*21.7	10	10310	25050
LFF010S	AC220-240V	10	800	90*150*20	20	41580	101000
LFF020S	AC220-240V	20	1600	120*170*20	20	29220	71000
LFF030S	AC220-240V	30	2400	150*210*21.9	20	19880	48300
LFF050S	AC220-240V	50	4000	190*250*21.3	10	13200	32120



# LED Work Light Bracket for LED Flood Light





# Plus-R Z Work Light Crystal-Z Work Light

Material  
Die-Casting Alu+ PC  
Quality Guarantee  
2 YEARS



Anti-UV

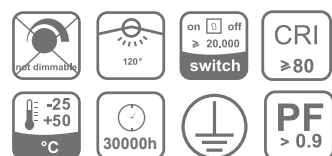

## Work Light Series



Crystal-Z Series LF0ZC010  
LF0ZC020  
LF0ZC030  
LF0ZC050



Plus-R Z Series LF0ZA020  
LF0ZA030  
LF0ZA050

## Chart Test Data

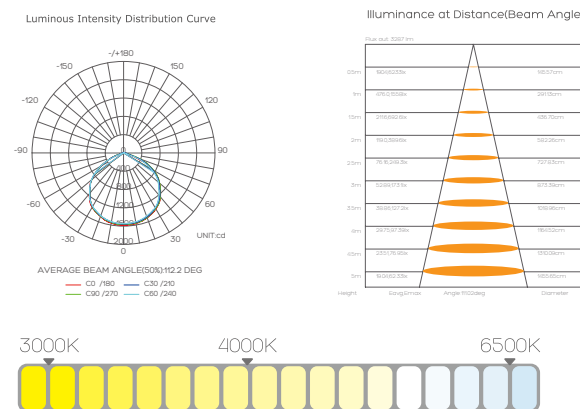

## Details



## Table Data

Part No	Voltage(V)	Power (W) Consumption	Lumen(lm)	Dimension(mm) (L*W*H)	pcs/CTN (pcs)	Qty. for 20GP	Qty. for 40HQ
LF0ZA020	AC220-240V	20	1400	210*180*240	10	5300	13000
LF0ZA030	AC220-240V	40	2100	245*180*270	10	3900	9400
LF0ZA050	AC220-240V	50	3500	280*180*300	10	3000	7400
LF0ZC010	AC220-240V	10	700	235*185*225	10	5700	13900
LF0ZC020	AC220-240V	20	1400	240*185*225	10	4700	11500
LF0ZC030	AC220-240V	30	2100	270*185*270	10	4100	10100
LF0ZC050	AC220-240V	50	3500	320*185*300	10	3200	7900



## A-Frame for Work Light

Holder Material

Iron + Nylon

Features

Lifting control for 3 levels

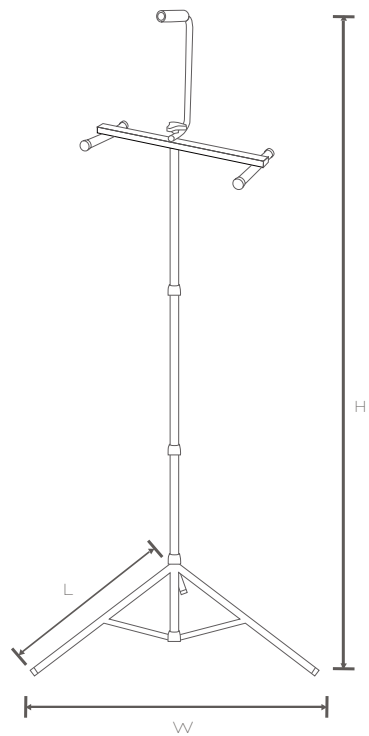

upper holder can be used alone

Part No.	Dimension(mm) (L*W*H)	Folded Size-upper(mm) (L*W*H)	Folded Size-under(mm) (L*W*H)	pcs/CTN (pcs)	Q'ty for 20GP	Q'ty for 40HQ
FS010H	770*770*1430	590*200*415	100*100*620	10	3800	9300
FS020H	770*770*1830	590*200*415	100*100*620	5	1450	3550

## New Spike for LED Floodlight

Material

PP+Dia-casting aluminum

Europe new spike standard:

Minimum distance between canble entry and stop plate

> 10cm

Quality Guarantee

2 YEARS

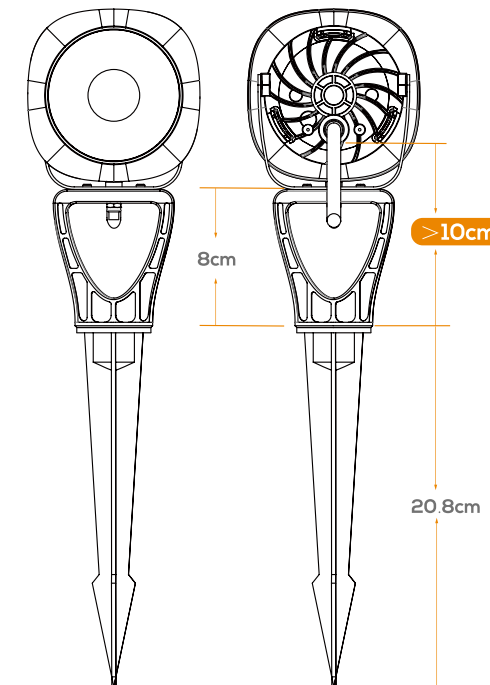







Part No.	Product Size (mm)	Remark
SPM5-210	20.8MM	Suitable for Plus-R only
SPM5-210-02	20.8MM	Suitable for Crystal,Plus-S



# LED Bulkhead Light

The out-door bulkhead lamps have been carefully designed with concerns to be durable, long-lasting and efficient. Selecting an energy efficient solution will contribute both to the environment and to reduce cost. The designs are well considered to create an illumination scenario that is reflecting the building or area's identity.

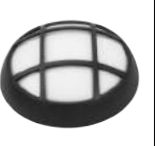
## LED Bulkhead Light

Series Name	Moon X	Stone	Gaudi	Moon	Moon Classical	Lynx Pro	Lynx
Photo							
Page	37-38	39-40	41-42	43-44	45-46	47-48	49-50
Diffuser	PC	PC	PC	PC	PC	PC	PP
Base	Die-casting Alu	PC	Die-casting Alu	PC	PC	pp	PC
Wattage	12W/20W	8W/15W	12W/20W	12W/18W	18W	8W/15W	15W
Lifetime	30000H	30000H	30000H	30000H	30000H	30000H	30000H
IK	10	8	10	8	8	8	8
Lm/W	> 80	> 80	> 80	> 80	> 80	> 70	> 70
PIR	X	X	X	X	X	Optional	Optional
Beam angle	120°	120°	120°	120°	120°	120°	120°
Pre-wired cable	√	Terminal box	Terminal box	Terminal box	Terminal box	Terminal box	X
Light source	LED	LED	LED	LED	LED or E26	LED	LED
Fast install							
Terminal block	X	X	√	X	X	X	X
Driver solution	Linear IC/Driver	Linear IC	Linear IC/Driver	Linear IC	Linear IC	Linear IC	Linear IC
ERP	X	X	X	X	X	√	X
CE/Rohs	√						
Dimmable	X						
Fixture color	black/ white/ grey	black/ white/ grey	black/ white/ grey	black/ white	black/ white	black/ white/ grey	black/ white/ grey
Available CCT	3000/4000/6000K						
Warranty	2years						

# Moon X

Material  
**Die-Casting Alu+ PC**  
 Quality Guarantee  
**2 YEARS**



Anti-UV



## Moon X Series



BHA1872121  
 BHA187212D1



BHA2316121  
 BHA231612D1



BHA2472201  
 BHA247220D1



BHA2916201  
 BHA291620D1

## Chart Test Data

10W-Luminous Intensity Distribution Curve

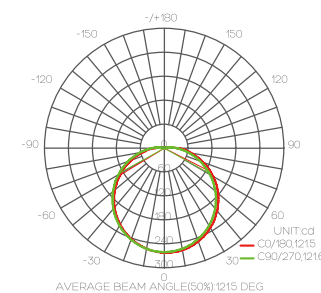

10W-Illuminance at Distance(Beam Angle)

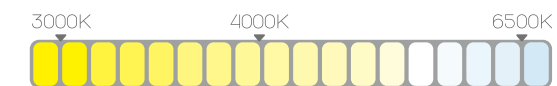
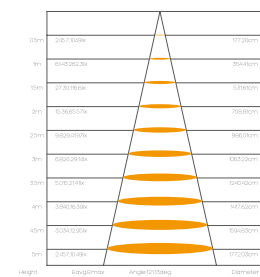

## Details



Fast installation

## Table Data

Part No	Voltage(V)	Wattage(W)	Driver	Lumen(lm)	Product Size (mm)	pcs/CTN (pcs)	Q'ty for 20GP	Q'ty for 40HQ
BHA2316121	AC220-240V	12	Linear IC	960	234*133*715	10	8000	19600
BHA231612D1	AC220-240V	12	Driver	960	234*133*715	10	8000	19600
BHA2916201	AC220-240V	20	Linear IC	1600	289*164*715	10	5500	13500
BHA291620D1	AC220-240V	20	Driver	1600	289*164*715	10	5500	13500
BHA1872121	AC220-240V	12	Linear IC	960	φ186.5*715	10	7550	18300
BHA187212D1	AC220-240V	12	Driver	960	φ186.5*715	10	7550	18300
BHA2472201	AC220-240V	20	Linear IC	1600	φ238.5*715	10	4700	11400
BHA247220D1	AC220-240V	20	Driver	1600	φ238.5*715	10	4700	11400

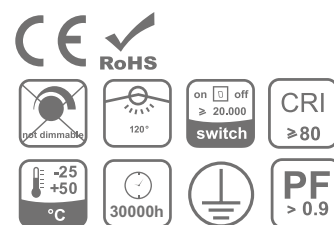



# Stone

Material  
**PC+ PC**  
 Quality Guarantee  
**2 YEARS**



Anti-UV



## Stone Series



## Chart Test Data

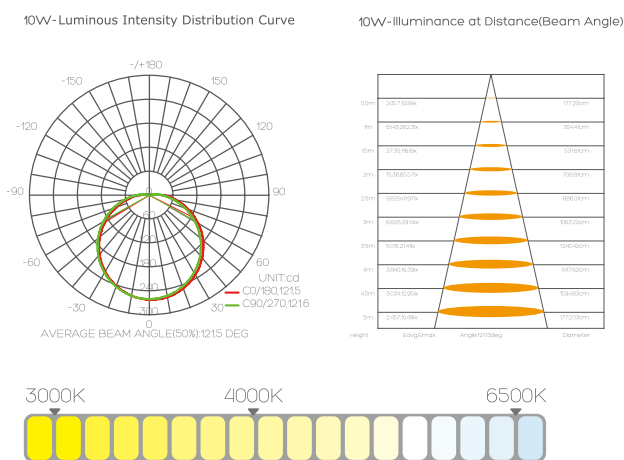

## Details



Fast installation

## Table Data

Part No.	Voltage(V)	Wattage(W)	Lumen(lm)	Product Size (mm)	pcs/CTN (pcs)	Q'ty for 20GP	Q'ty for 40HQ
BHD169C080	AC220-240V	8	700	169*151*52	10	12800	31000
BHD232C150	AC220-240V	15	1300	232*206*52	10	7400	17900
BHD161E080	AC220-240V	8	700	161*91*49	10	20800	50600
BHD211E150	AC220-240V	15	1300	211*119*49	10	12900	31300
BHD169C081	AC220-240V	8	500	169*155*56	10	11500	28000
BHD232C151	AC220-240V	15	1100	232*211*56	10	6700	16300
BHD165E081	AC220-240V	8	500	165*95*54	10	18000	43800
BHD215E151	AC220-240V	15	1100	215*123*54	10	11300	27500

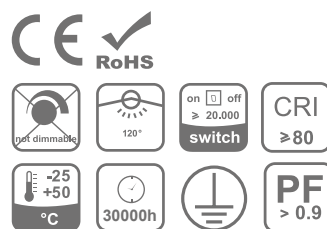

# Gaudi

Material

Die-Casting Alu+ PC

Quality Guarantee

2 YEARS



Anti-UV



**EUROPEAN  
PRODUCT  
DESIGN  
AWARD**

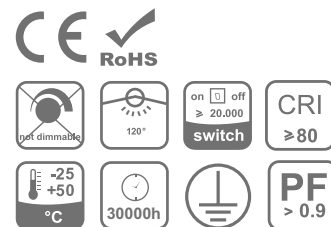

## Gaudi Series



BHE1869121  
BHE186912D1

BHE2274201  
BHE227420D1

BHE1812121  
BHE181212D1

BHE2314201  
BHE231420D1

## Chart Test Data

10W-Luminous Intensity Distribution Curve

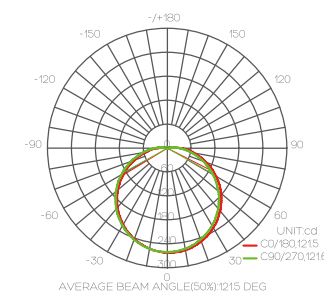

10W-Illuminance at Distance(Beam Angle)

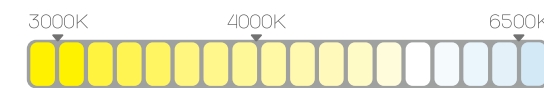
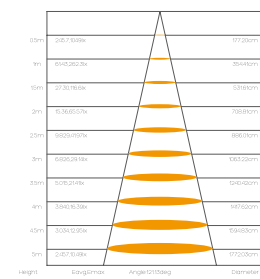

## Details



Fast installation

## Table Data

Part No.	Voltage(V)	Wattage(W)	Lumen(lm)	Driver	Product Size (mm)	pcs/CTN (pcs)	Q'ty for 20GP	Q'ty for 40HQ
BHE1869121	AC220-240V	12	960	Linear IC	φ180*68.5	10	7900	19200
BHE186912D1	AC220-240V	12	960	Non-isolated	φ180*68.5	10	7900	19200
BHE2274201	AC220-240V	20	1600	Linear IC	φ220*73.5	10	5200	12700
BHE227420D1	AC220-240V	20	1600	Non-isolated	φ220*73.5	10	5200	12700
BHE1812121	AC220-240V	12	960	Linear IC	188*128*68.5	10	10100	24500
BHE181212D1	AC220-240V	12	960	Non-isolated	188*128*68.5	10	10100	24500
BHE2314201	AC220-240V	20	1600	Linear IC	230*140*73.5	10	7500	18300
BHE231420D1	AC220-240V	20	1600	Non-isolated	230*140*73.5	10	7500	18300

# Moon

Material  
PC+PC  
Quality Guarantee  
**2 YEARS**



Anti-UV

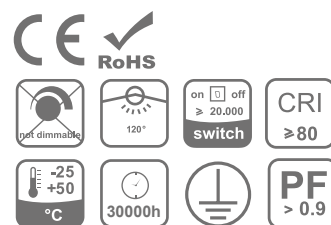

## Moonus Series



BHFE195C120  
BHFE245C180



BHFE195C121  
BHFE245C181



BHFE240E120  
BHFE300E180

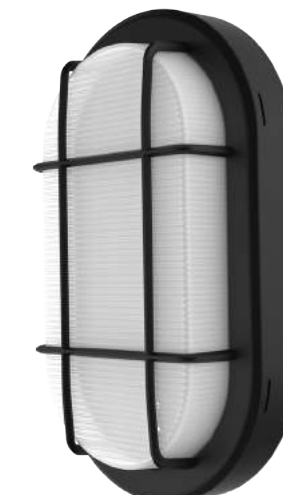

BHFE240E121  
BHFE300E181

## Chart Test Data

Luminous Intensity Distribution Curve

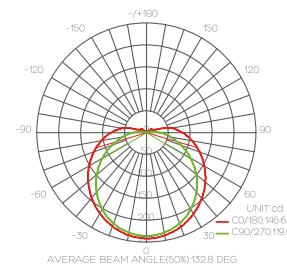

Illuminance at Distance(Beam Angle)

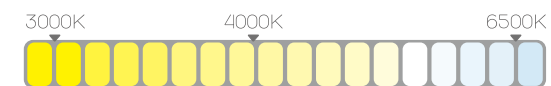
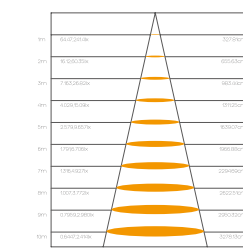

## Details



Easy replaceable frame

## Table Data

Part No.	Voltage(V)	Wattage(W)	Lumen(lm)	Product Size (mm)	pcs/CTN (pcs)	Q'ty for 20GP	Q'ty for 40HQ
BHFE195C120	AC220-240V	12	900	φ193*63	20	8000	19800
BHFE245C180	AC220-240V	18	1500	φ248*63	20	5000	12400
BHFE240E120	AC220-240V	12	900	242*142*63	20	8800	21500
BHFE300E180	AC220-240V	18	1500	297*172*63	20	6000	14800
BHFE195C121	AC220-240V	12	700	φ193*70	20	7200	17400
BHFE245C181	AC220-240V	18	1300	φ248*70	20	4400	11000
BHFE240E121	AC220-240V	12	700	242*142*70	20	7800	19000
BHFE300E181	AC220-240V	18	1300	297*172*70	20	5400	13200



# Moon Classical

Material

PC + PC

Quality Guarantee

2 YEARS



Anti-UV



## Moonus Classical Series



BHGE245C180  
BHGE245C180M  
BHGE245C18B0



BHGE245C181  
BHGE245C181M  
BHGE245C18B1



BHGE300E180  
BHGE300E180M  
BHGE300E18B0



BHGE300E181  
BHGE300E181M  
BHGE300E18B1

## Chart Test Data

Luminous Intensity Distribution Curve

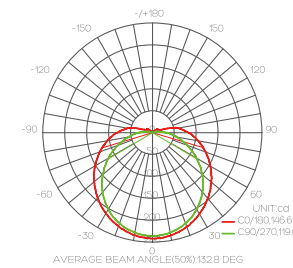

Illuminance at Distance (Beam Angle)

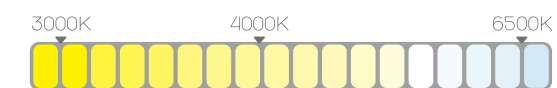
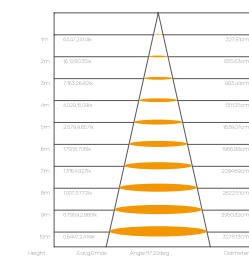

## Details



Easy replaceable frame

## Table Data

Part No.	Voltage(V)	Wattage(W)	Lumen(lm)	Microwave sensor	Light source	Product Size (mm)	pcs/CTN (pcs)	Q'ty for 20GP	Q'ty for 40HQ
BHGE300E180	AC220-240V	18	1500	X	LED	297*172*100	20	4000	9800
BHGE300E180M	AC220-240V	18	1500	√	LED	297*172*100	20	4000	9800
BHGE300E18B0	AC220-240V	18	1500	X	E26/E27	297*172*100	20	4000	9800
BHGE300E181	AC220-240V	18	1300	X	LED	297*172*106	20	3800	9400
BHGE300E181M	AC220-240V	18	1300	√	LED	297*172*106	20	3800	9400
BHGE300E18B1	AC220-240V	18	1300	X	E26/E27	297*172*106	20	3800	9400
BHGE245C180	AC220-240V	18	1500	X	LED	φ248*100	20	3400	8340
BHGE245C180M	AC220-240V	18	1500	√	LED	φ248*100	20	3400	8340
BHGE245C18B0	AC220-240V	18	1500	X	E26/E27	φ248*100	20	3400	8340
BHGE245C181	AC220-240V	18	1300	X	LED	φ248*104	20	3200	8000
BHGE245C181M	AC220-240V	18	1300	√	LED	φ248*104	20	3200	8000
BHGE245C18B1	AC220-240V	18	1300	X	E26/E27	φ248*104	20	3200	8000

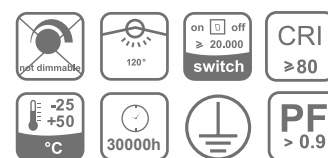

# Lynx Pro

Material  
**Die-Casting Alu+ PC**  
 Quality Guarantee  
**2 YEARS**



Anti-UV

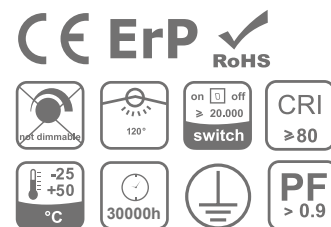

## Lynx Pro Series



BHB17080  
BHB26150



BHB17080S  
BHB26150S



BHB17080M  
BHB26150M

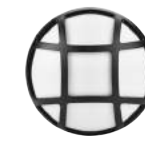

BHB17081  
BHB26151



BHB17081S  
BHB26151S

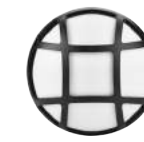

BHB17081M  
BHB26151M



BHB17082  
BHB26152



BHB17082S  
BHB26152S



BHB17082M  
BHB26152M

## Chart Test Data

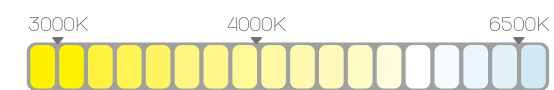
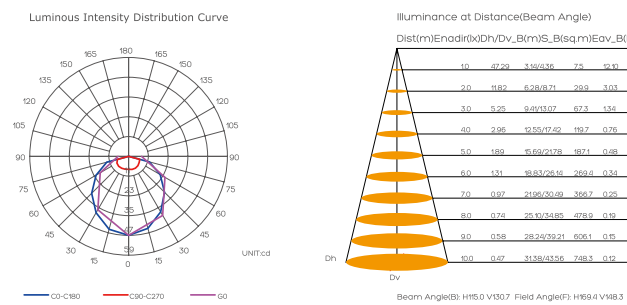

## Details

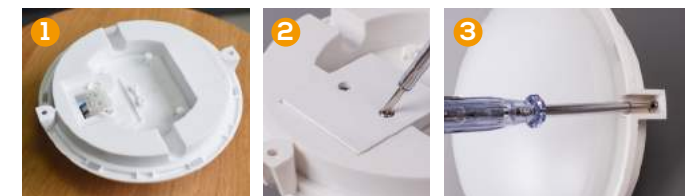

## Table Data

Part No.	Voltage(V)	Wattage(W)	Lumen(lm)	Product Size (mm)	pcs/CTN (pcs)	Q'ty for 20GP	Q'ty for 40HQ
BHB17080 BHB17080S BHB17080M	AC220-240V	8	560	φ170*57	24	12720	30960
BHB17081 BHB17081S BHB17081M	AC220-240V	8	400	φ170*57	24	12720	30960
BHB17082 BHB17082S BHB17082M	AC220-240V	8	400	φ170*61	24	12720	30960
BHB26150 BHB26150S BHB26150M	AC220-240V	15	1050	φ260*84	16	3840	9440
BHB26151 BHB26151S BHB26151M	AC220-240V	15	900	φ260*84	16	3840	9440
BHB26152 BHB26152S BHB26152M	AC220-240V	15	750	φ260*90	16	3840	9440

# Lynx

Material  
**PC + ABS + PP**  
 Quality Guarantee  
**2 YEARS**



Anti-UV



## Lynx Series



BHA2816150



BHA2816153



BHA2816150S

## Chart Test Data

Luminous Intensity Distribution Curve

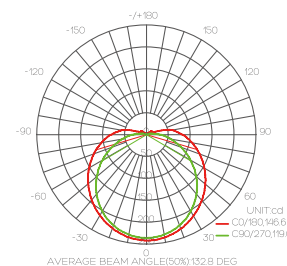

Illuminance at Distance (Beam Angle)

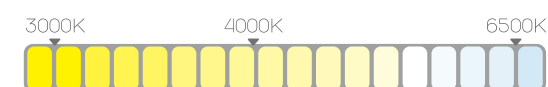
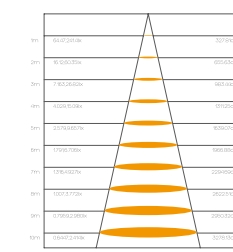

## Table Data

Part No.	Voltage(V)	Wattage(W)	Lumen(lm)	Product Size (mm)	pcs/CTN (pcs)	Q'ty for 20GP	Q'ty for 40HQ
BHA2816150	AC220-240V	15	800	285*165*99	12	4560	11040
BHA2816153	AC220-240V	15	750	285*165*99	12	4560	11040
BHA2816150S	AC220-240V	15	800	285*165*99	12	4560	11040

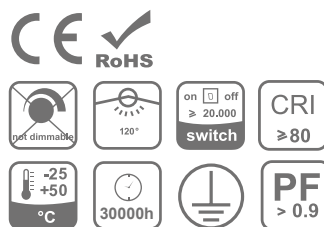





## LED Tri-proof Light

LED Tri-proof luminaires are an eco-friendly alternative to traditional fluorescent lighting systems and will help you reduce your energy consumption. Incredibly durable and long lasting, these luminaires are highly resistant to heavy impacts, jets of water, dust, and to temperature variations. These Tri-proof luminaires are for applications where the possibility of vandalism is high. Such as subway stations, stairwells, hallways, schools etc.

# Cosmos

Material

PC+PC

Quality Guarantee

2 YEARS



Anti-UV

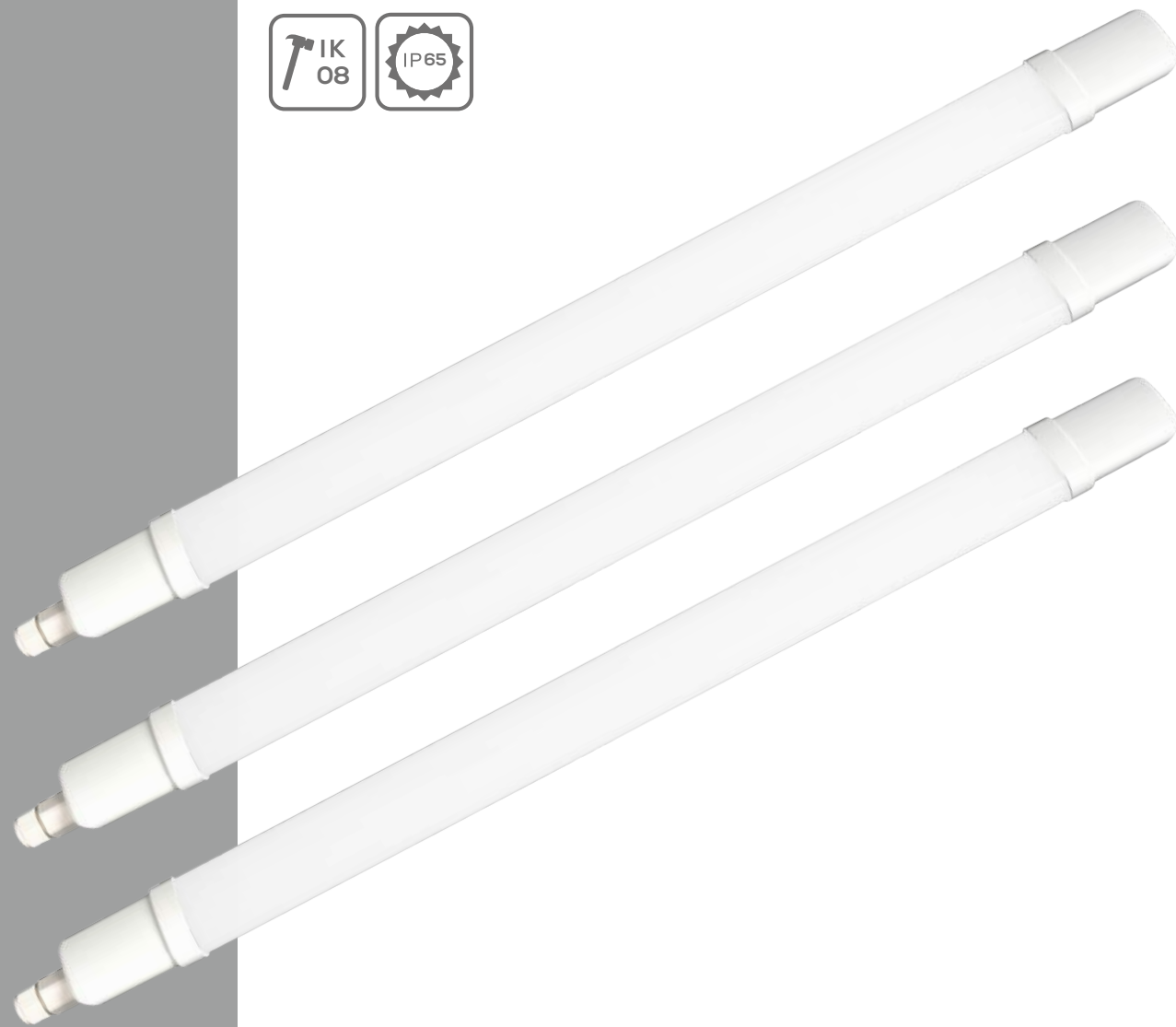

## Cosmos Series



RJA60018



RJA123036



RJA153045

## Chart Test Data

Luminous Intensity Distribution Curve

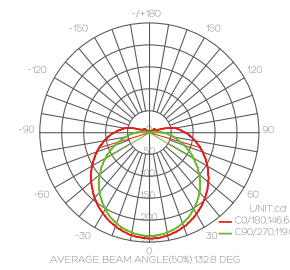

Illuminance at Distance(Beam Angle)

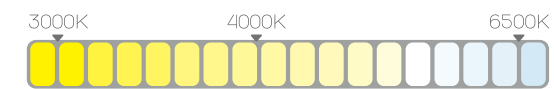
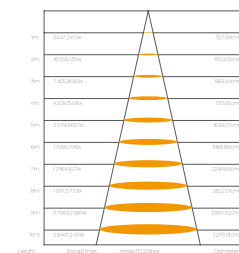

## Details



## Table Data

Part No	Voltage(V)	Wattage(W)	Lumen(lm)	Product Size (mm)	pcs/CTN (pcs)	Q'ty for 20GP	Q'ty for 40HQ
RJA60018	AC220V-240V	18	1600	600*53*35	20	13200	32060
RJA123036	AC220V-240V	36	3500	1230*53*35	20	7760	18860
RJA153045	AC220V-240V	45	4300	1530*53*35	20	6360	15480

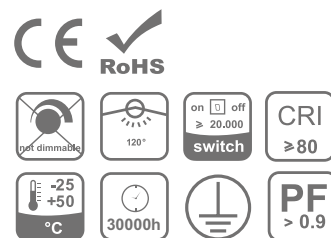

# Cosmos Plus

Material

PC+PC

Quality Guarantee

2 YEARS



Anti-UV



## Cosmos Plus Series



RJB60020

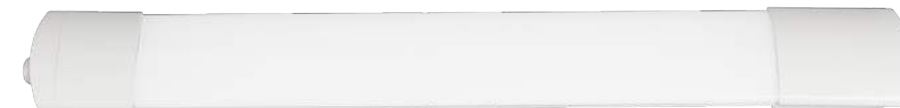

RJB120040



RJB150050

## Chart Test Data

Luminous Intensity Distribution Curve

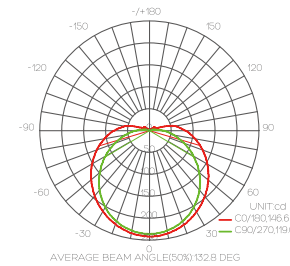

Illuminance at Distance(Beam Angle)

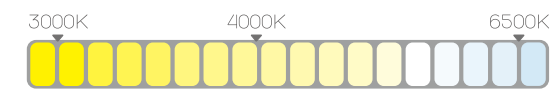
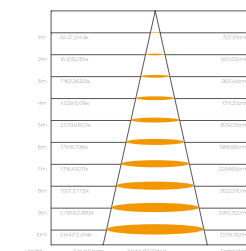

## Details

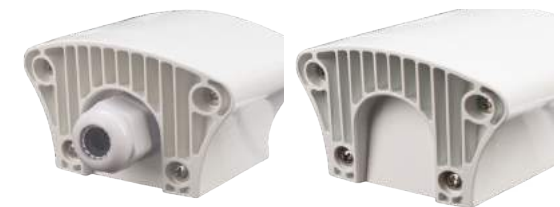

## Table Data

Part No.	Voltage(V)	Wattage(W)	Lumen(lm)	Product Size (mm)	pcs/CTN (pcs)	Q'ty for 20GP	Q'ty for 40HQ
RJB60020	AC220V-240V	20	1800	600*78*50	12	13000	31600
RJB120040	AC220V-240V	40	3600	1200*78*50	8	10340	25140
RJB150050	AC220V-240V	50	4500	1500*78*50	8	8340	20300

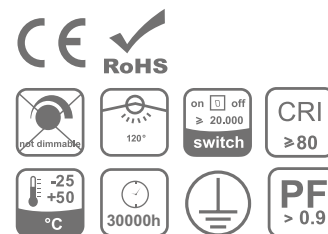



# Packing Display



# IP CLASS

1 <sup>st</sup> digit :protection against solid bodies			2 <sup>st</sup> digit :protection against liquids		
IP	tests		IP	tests	
0		No protection	0		No protection
1	50 mm	Protected against solid bodies larger than 50-mm (eg: accidental contact with the hand)	1	1	Protected against vertically-falling drops of water (condensation)
2	12.5 mm	Protected against solid bodies larger than 12-mm (eg: finger)	2	15°	Protected against drops of water falling at up to 15° from the vertical
3	25 mm	Protected against solid bodies larger than 25-mm (eg: tools, wires)	3	60°	Protected against drops of rain water at up to 60° from the vertical
4	1 mm	Protected against solid bodies larger than 1 mm (eg: fine tools and small wires)	4	4	Protected against projections of water from all directions
5	5	Protected against dust (no harmful deposit)	5	5	Protected against jets of water from all directions
6	6	Completely protected against dust	6	6	Protected against jets of water of similar force to heavy seas
			7	1m, 15 min	Protected against the effects of immersion the effects of immersion
			8	8	Protected against pro-longed effects of immersion under pressure

# APPLIANCE CLASS

0		These appliances have no protective-earth connection and feature only a single level of insulation between live parts and exposed metalwork.
I		These appliances must have their chassis connected to electrical earth by a separate earth conductor
II		These appliances are designed in such a way that it does not require a safety connection to electrical earth
III		These appliances are designed to be supplied from a separated/safety extra-low voltage (SELV) power source

# IK CLASS

IK	Tests	Impact energy (in Joules)	IK05	IK06	IK07	IK08	IK09	IK10
IK00		0	0.2 kg, 350 mm	0.5 kg, 200 mm	0.5 kg, 400 mm	1.7 kg, 295 mm	5 kg, 200 mm	5 kg, 400 mm
IK01	0.2 kg, 75 mm	0.15						
IK02	0.2 kg, 100 mm	0.2						
IK03	0.2 kg, 175 mm	0.35						
IK04	0.2 kg, 250 mm	0.5						

# Appendix

Product	Series	Model	Page	
LED Flood Light	Tynee	LFP0F010	LFP0F010-T	7-8
		LFP0F020	LFP0F020-T	
		LFP0F030	LFP0F030-T	
		LFP0F050	LFP0F050-T	
		LFP0F070	LFP0F070-T	
		LFP1F010	LFP1F010-T	
		LFP1F020	LFP1F020-T	
		LFP1F030	LFP1F030-T	
		LFP1F050	LFP1F050-T	9-10
		LFP1F070	LFP1F070-T	
		LFP0F010S	LFP0F010S-T	
		LFP0F020S	LFP0F020S-T	
		LFP0F030S	LFP0F030S-T	
		LFP0F050S	LFP0F050S-T	
		LFP0F070S	LFP0F070S-T	
		LFP1F010S	LFP1F010S-T	
		LFP1F020S	LFP1F020S-T	
		LFP1F030S	LFP1F030S-T	
		LFP1F050S	LFP1F050S-T	
		LFP1F070S	LFP1F070S-T	11-12
		LFG0F010	LFG0F010-T	
		LFG0F020	LFG0F020-T	
		LFG0F030	LFG0F030-T	
		LFG0F050	LFG0F050-T	
		LFG0F070	LFG0F070-T	
		LFG1F010	LFG1F010-T	
		LFG1F020	LFG1F020-T	
		LFG1F030	LFG1F030-T	
	LFG1F050	LFG1F050-T		
	LFG1F070	LFG1F070-T	13-14	
	LFG0F010S	LFG0F010S-T		
	LFG0F020S	LFG0F020S-T		
	LFG0F030S	LFG0F030S-T		
	LFG0F050S	LFG0F050S-T		
	LFG0F070S	LFG0F070S-T		
	LFG1F010S	LFG1F010S-T		
	LFG1F020S	LFG1F020S-T		
	LFG1F030S	LFG1F030S-T		
	LFG1F050S	LFG1F050S-T		
	LFG1F070S	LFG1F070S-T	15-16	
	SLFP0F010	SLFP0F010S		
	SLFP0F020	SLFP0F020S		
	SLFG0F010	SLFG0F010S		
	SLFG0F020	SLFG0F020S	17-18	
	LF00E010	LF00E010-T		
	LF00E020	LF00E020-T		
	LF00E030	LF00E030-T		
	LF00E050	LF00E050-T		
	LF00E010S	LF00E010S-T		
	LF00E020S	LF00E020S-T	19-20	
	LF00E030S	LF00E030S-T		
	LF00E050S	LF00E050S-T		
	LF00D010	LF00D010-T	21-22	
	LF00D020	LF00D020-T		
	LF00D030	LF00D030-T		
	LF00D050	LF00D050-T		
	LF00B010	LF00B010-T	23-24	
	LF00B020	LF00B020-T		
	LF00B030	LF00B030-T		
	LF00B050	LF00B050-T		
LF00B010S	LF00B010S-T			
LF00B020S	LF00B020S-T			
LF00B030S	LF00B030S-T			
LF00B050S	LF00B050S-T			
LF0SC010-24W	LF0SC030-60W	25-26		
LF0SC020-34W	LF0SC050-80W			
LFF010	LFF010S	27-28		
LFF020	LFF020S			
LFF030	LFF030S			
LFF050	LFF050S			
LFF100				

Product	Series	Model	Page	
LED Flood Light	work Light	LF0ZA020	LF0ZC010	31-32
		LF0ZA030	LF0ZC020	
		LF0ZA050	LF0ZC030	
Frame for LED Flood Light	Bracket for Work Light	FS010H	FS020H	33
	New Spike	SPM5-210	SPM5-210-02	34
LED Bulkhead Light	Moon X	BHA2316121	BHA2916201	37-38
		BHA231612D1	BHA291620D1	
		BHA1872121	BHA2472201	
		BHA187212D1	BHA247220D1	
	Stone	BHD169C080	BHD169C081	39-40
		BHD232C150	BHD232C151	
		BHD161E080	BHD165E081	
		BHD211E150	BHD215E151	
	Gaudi	BHE1869121	BHE1812121	41-42
		BHE186912D1	BHE181212D1	
		BHE2274201	BHE2314201	
	Moon	BHE227420D1	BHE231420D1	43-44
		BHFE195C120	BHFE195C121	
		BHFE245C180	BHFE245C181	
	Moon classical	BHFE240E120	BHFE240E121	45-46
		BHFE300E180	BHFE300E181	
		BHGE300E180	BHGE245C180	
		BHGE300E180M	BHGE245C180M	
	Lynx Pro	BHGE300E18B0	BHGE245C18B0	47-48
		BHGE300E181	BHGE245C181	
BHGE300E181M		BHGE245C181M		
BHGE300E18B1		BHGE245C18B1		
BHB17080		BHB26150		
BHB17080S		BHB26150S		
BHB17080M		BHB26150M		
BHB17081		BHB26151		
BHB17081S		BHB26151S		
BHB17081M		BHB26151M		
BHB17082	BHB26152			
BHB17082S	BHB26152S			
BHB17082M	BHB26152M	49-50		
BHA2816150	BHA2816153			
LED Tri-proof Light	Lynx	RJA60018	RJA123036	53-54
	Cosmos	RJA153045		
LED Tri-proof Light	Cosmos Plus	RJB60020	RJB120040	55-56
		RJB150050		